

RST®

WATERPROOF CONNECTORS

Highest Protection Connectors Rated for North America

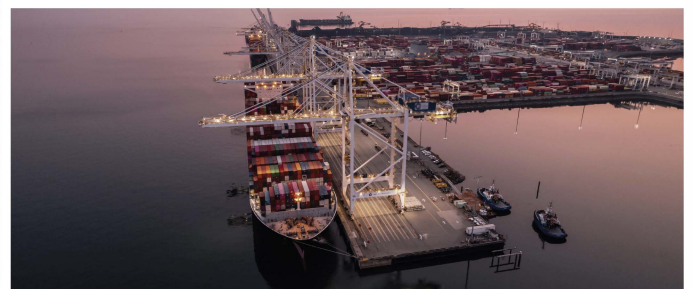

CONTENTS

RST® MICRO	Introduction – RST08	7	
	RST08i Plug connectors, 2-5 poles	10	
	RST08i Device connectors, 2-5 poles	11	
	RST08i Distributors, 2-5 poles	12	
	RST08i Accessories	14	
RST® MINI	Introduction – RST16	15	
	RST16i Plug connectors, 2-5 poles	17	
	RST16i Device connectors, 2-5 poles	18	
	RST16i Distributors, 2-5 poles	19	
	RST16 Accessories	20	
	MOLA The Perfect Light Fixture Connector	21	
RST® CLASSIC	Introduction – RST20	23	
	RST20i2/3 Plug connectors, 2-3 poles	25	
	RST20i2/3 Device connectors, 2-3 poles	27	
	RST20i2/3 Distributors, 2-3 poles	29	
	RST20i4/5 Plug connectors, 4-5 poles	30	
	RST20i4/5 Device connectors, 4-5 poles	31	
	RST20i4/5 Distributors, 4-5 poles	32	
	RST20i6/7 Plug connectors, 6-7 poles	33	
	RST20i6/7 Device connectors 6-7 poles	34	
	RST20i6/7 Splitters 6-7 poles	35	
	RST25i3 Plug connectors, splitter, 3-pole	36	
	RST25i3 Device connector, 3-pole	37	
	RST25i5 Plug connectors, splitter, 5-pole	38	
	RST25i5 Device connector, 5-pole	39	
	RST16/20 Cable Assemblies	40	
	RST20/25 Accessories	41	
	RST® POWER	Introduction – RST50	43
		RST50i4/5 Plug connectors, device connectors, 4-5 poles	44
RST50 Accessories		45	
Cable Glands	Cable Gland + Vented Plugs at a Glance	46	

FAST, EASY + SAFE INSTALLATION

If you could save 75% of the installation time of your electrical system what would you do with the extra time?

Would you win more projects, focus on expanding your operations, or perhaps develop a new product or service?

Time saved is not the only benefit that the RST® pluggable connector system brings to your project. Standard interfaces and custom cable assemblies allow you to plan ahead with confidence. Respond quickly to change requests, reuse components, and ensure a long service life for the installation.

RST® SYSTEM OVERVIEW

TYPE 4X / 6P

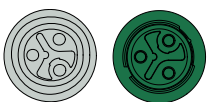
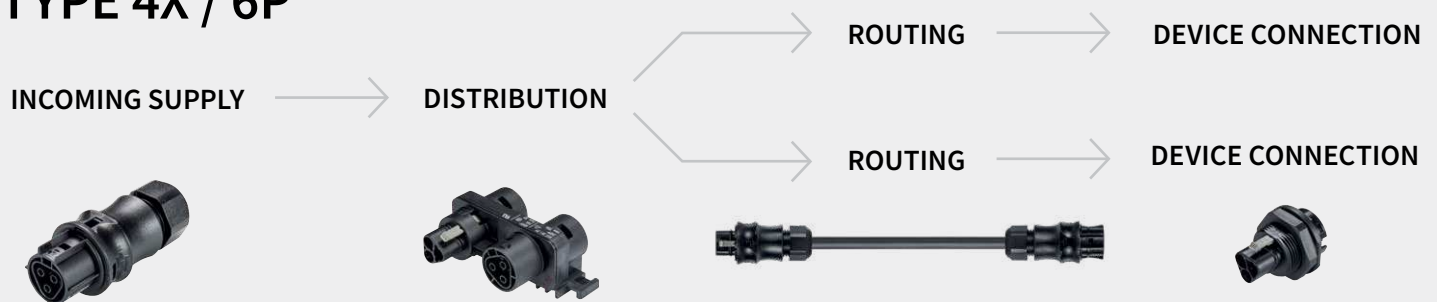

SMART CODING

RST® connectors ensure the highest degree of **safety** and **error-free installation** with color and mechanical coding.

SYSTEM BENEFITS

- ▶ Waterproof against high-pressure water jets
- ▶ Optional water seal for added protection when unmated
- ▶ Flexible & modular
- ▶ Fast installation & easy changes or expansions
- ▶ Resource-efficient
- ▶ Reusable & safe

FEATURES AT A GLANCE

- ▶ Type 4X / 6P
- ▶ Rated up to 600 V and 53 A
- ▶ Pre-assembled cable harnesses and distribution units
- ▶ Locking mechanism
- ▶ Color & mechanical coding

SUCCESS STORY

VERTICAL CITY FARM APPLICATION

To help with a new vertical farm installation, Wieland provided its customer with a waterproof, pluggable and easy to install electrical system for its grow lights. Our engineering department worked closely with the customer to come up with a **customized electrical architecture**. The pluggable nature of the installation **saved 70% of installation time** compared to what a typical pipe and wire installation would have required.

By providing our customer with **custom cable harnesses**, they could easily replicate the system in subsequent farms, knowing exactly the lengths and type of connectors they would need. This allowed the customer to expand their business quicker and gain customers faster than their competitor. In addition, the smart coding system of the connectors **eliminated installation errors** and did not require a special skills worker to be installed.

CONVENTIONAL INSTALLATION



20 MIN

STEPS:

- POWER DISTRIBUTION:**
- 1 Cut the cable to length
 - 2 Strip the cable sheath
 - 3 Insert the cable into the junction box
 - 4 Strip the wire insulation
 - 5 Connect the individual wires
 - 6 Close the junction box

- LIGHTING INSTALLATION:**
- 1 Open the luminaire
 - 2 Cut the cable to length
 - 3 Insert the wire into the luminaire
 - 4 Strip the wire insulation
 - 5 Connect the individual wires
 - 6 Close the luminaire

Watch the comparison



PLUGGABLE INSTALLATION FROM WIELAND WITH RST®



4 MIN

STEPS:

- POWER DISTRIBUTION:**
- 1 Cable assemblies made to order based on your specifications
 - 2 Plug into distribution block
- LIGHTING INSTALLATION:**
- 1 Plug & turn on!

ADDITIONAL ADVANTAGES OVER CONVENTIONAL INSTALLATION:

- + Touch-safe
- + Simple cable layout
- + Plug & play replacement of devices
- + Easy expansions or modifications
- + Reusable
- + Smart coding
- + Integrated locking and strain relief

4 SIZES TO FIT ANY APPLICATION



RST® POWER

Greatest amount of energy for power-intensive applications.

4 and 5 poles,
Rated to 600 V, 53 A

Diameter:
65 mm



RST® CLASSIC

All-purpose connector with the broadest portfolio

2 to 7 poles,
Rated to 600 V, 20 A (25 A)

Diameter:
34.7mm



RST® MINI

Small connector for confined spaces

2 to 5 poles,
Rated to 600 V, 16 A

Diameter:
19 mm (2/3 pole)
24.9 mm (4/5 pole)



RST® MICRO

Small connector for extremely confined spaces

2 to 5 poles,
Rated to 400 V, 8 A

Diameter:
14.9 mm (2/3 pole)
20 mm (4/5 pole)



All Wieland RST® connectors have a Type 4X, Type 6P or both types protection!

ENCLOSURE RATINGS EXPLAINED

IP Ratings:

- IP65** Dust tight & protected against water from a nozzle
- IP66** Dust tight & protected against powerful jets of water

- IP67** Dust tight & protected against temporary submersion (30min)
- IP68** Dust tight & protected against extended submersion

- IP69** Dust tight & protected against high temperature, high pressure water, and steam

Type Ratings:

- Type 4** Protection against dust, ice and hose-directed water
- Type 4X** Type 4 protection + protection against corrosion

- Type 6** Protection against dust, ice and temporary submersion
- Type 6P** Type 6 + protection against prolonged submersion (1.8m; 24h)

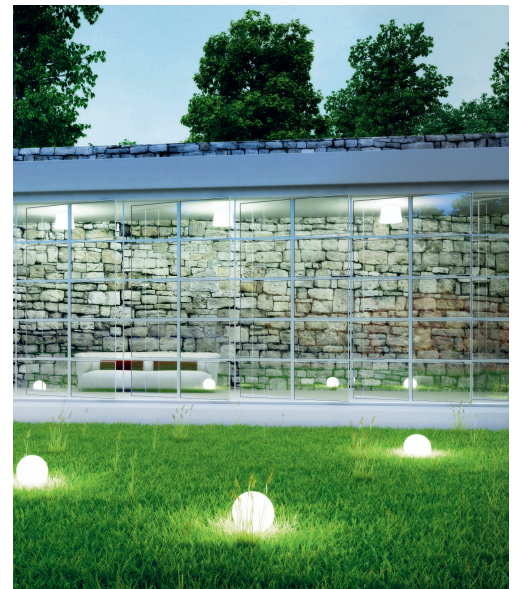

General **Electrical** Certification



Marine Certification



RINA

RST® MICRO

The smallest connectors for extremely confined spaces.

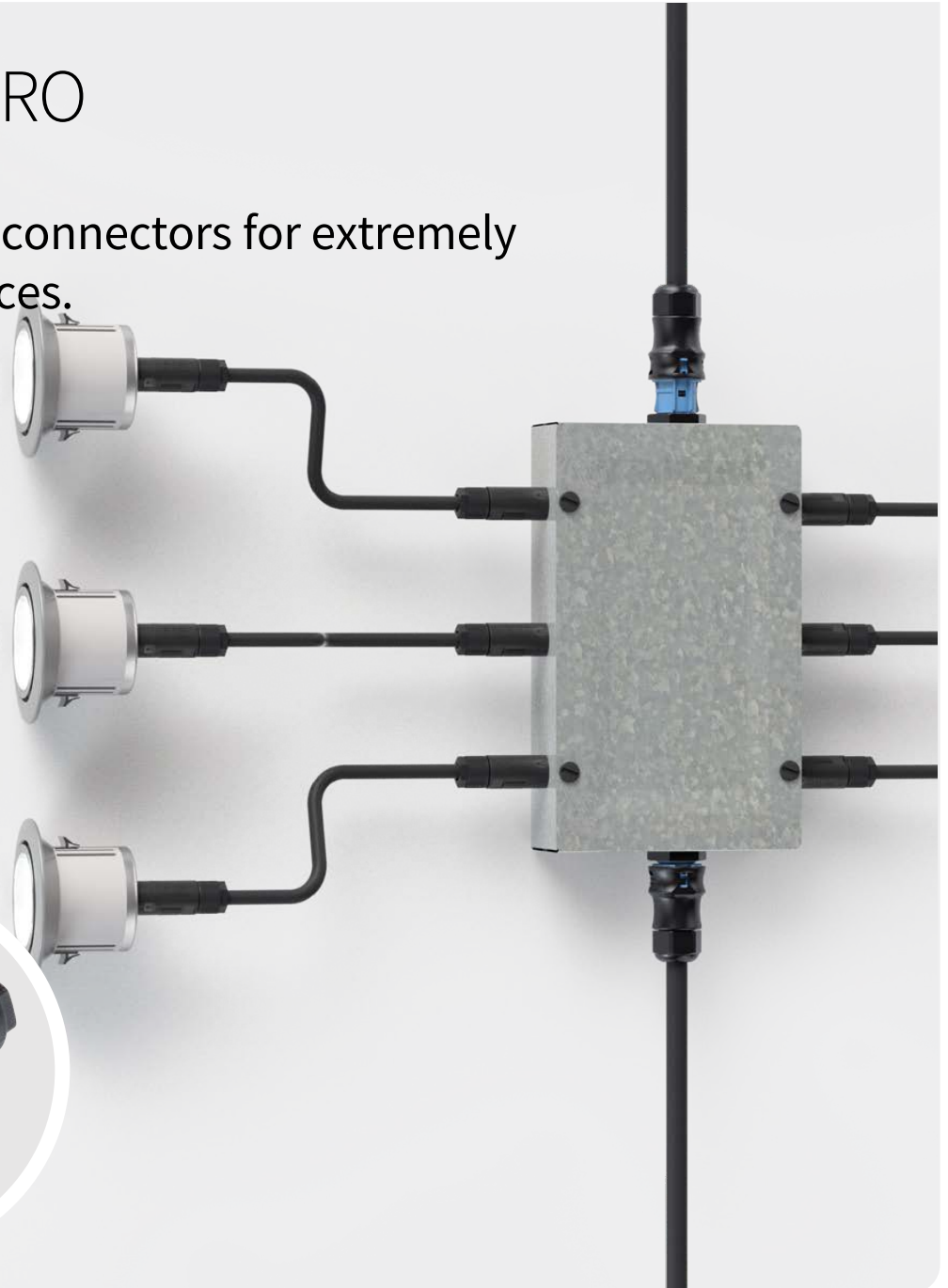

FEATURES

- + 2 to 5 poles
- + Rated up to 400 V and 8 A
- + Mechanical + color coding
- + Locking mechanism
- + Protection up to Type 4X / 6P
- + Optional contact seal

APPLICATIONS

- + Outdoor and high moisture environments
- + Confined spaces
- + Great for demanding outdoor environments such as event technology, garden lighting, and illuminated displays



QUICKLY PLUGGED

No screwing or turning required - the lock engages automatically when plugged together.



EASY WIRE CONNECTION

With hexagon socket screws the screwdriver can be fastened and the wire can be connected much easier.

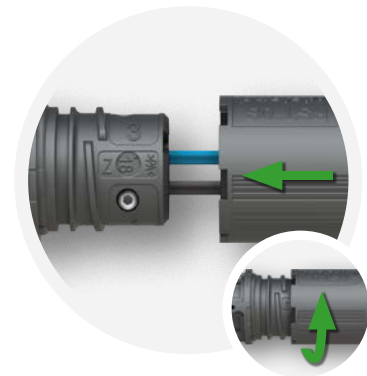

CONVENIENT QUICK-RELEASE FASTENER

Attach the external housing close it with only half a rotation.



FITS THROUGH STANDARD PIPES

With diameters of 14.9 mm and 20 mm, the connectors can be pulled through standard steel conduits.



CAN BE INTEGRATED IN EXISTING INSTALLATIONS

Can be integrated into through-holes of 14 mm (2-/3-pole) and 17 mm (4-/5-pole).



SAFE INSTALLATION THANKS TO MECHANICAL + COLOR CODING

All connectors are coded when they leave the factory, so mismatching is effectively prevented.



INSTALLED WITH FORESIGHT USING SAFETY LOCK

According to IEC61984, the strain relief (cable gland) must withstand a tensile force of 80 N for one minute. Our 60 N locking mechanism guarantees a secure hold of the connection, which opens in the event of an exceptionally high tensile force. This means that the high tensile force does not act on the strain relief and dangerous pulling of the conductors out of the contact points is avoided. Therefore, a locking device that can hold significantly more than the strain relief and the contact points is not recommended.

RST08i2

**Mechanical coding** (view on connector interface female)

black

light blue

slate gray

pebble gray

Operating voltage (application)

Up to 400 V

RST08i3

**Mechanical coding** (view on connector interface female)

black

light blue

slate gray

pebble gray

Operating voltage (application)

Up to 400 V

RST08i4

**Mechanical coding** (view on connector interface female)

black

light blue

slate gray

pebble gray

Operating voltage (application)

Up to 400 V

RST08i5

**Mechanical coding** (view on connector interface female)

black

light blue

slate gray





pebble gray

Operating voltage (application)

Up to 400 V

RST08I, CONNECTOR, 2-5 POLES

SCREW CONNECTION

TECHNICAL DATA				
	2/3 Poles		4/5 Poles	
	IEC		IEC	
Cable Ø	5.0 - 9.5 mm		7.1 - 13 mm	
Voltage	250/400 V	400 V	250/400 V	400 V
Current	8 A		8 A	
Wire Size	0.2 - 1.0 mm ²	24 - 20 AWG  22 - 20 AWG	0.2 - 1.0 mm ²	24 - 18 AWG  22-18 AWG
Protection	IP69	Type 4X / 6P	IP69	Type 4X / 6P

female

male



straight, for cables Ø 4-7 mm

Color of coding	Poles	female Part No.	male Part No.
■ black	2	41.021.3043.1	41.022.3043.1
■ light blue	2	41.021.3043.9	41.022.3043.9
■ pebble grey	2	41.021.3041.8	41.022.3041.8
■ slate grey	2	41.021.3041.4	41.022.3041.4

female

male



straight, for cables Ø 4-7 mm

Color of coding	Poles	female Part No.	male Part No.
■ black	3	41.031.3053.1	41.032.3053.1
■ light blue	3	41.031.3043.9	41.032.3043.9
■ pebble grey	3	41.031.3051.8	41.032.3051.8
■ slate grey	3	41.031.3041.4	41.032.3041.4

female

male



pluggable, straight, for cables Ø 5-10.6 mm

Color of coding	Poles	female Part No.	male Part No.
■ black	4	41.041.3053.1	41.042.3053.1
■ light blue	4	41.041.3043.9	41.042.3043.9
■ pebble grey	4	41.041.3041.8	41.042.3041.8
■ slate grey	4	41.041.3041.4	41.042.3041.4

female

male



straight, for cables Ø 5-10.6 mm

Color of coding	Poles	female Part No.	male Part No.
■ black	5	41.051.3053.1	41.052.3053.1
■ light blue	5	41.051.3043.9	41.052.3043.9
■ pebble grey	5	41.051.3051.8	41.052.3051.8
■ slate grey	5	41.051.3041.4	41.052.3041.4



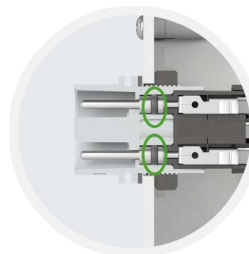

Optional **water seals** on individual contacts for added protection when unmated (refer to page 23).



To order the part with an internal contact seal, replace '41' with '4L' in the part number.
Example 41.021.4041.4 > 4L.021.4041.4

RST08I, DEVICE CONNECTOR, 2-5 POLES

SCREW CONNECTION

TECHNICAL DATA				
	2/3 Poles		4/5 Poles	
	IEC		IEC	
Thread Size	M14		M16.6	
Voltage	250/400 V	400 V	250/400 V	400 V
Current	8 A		8 A	
Wire Size	0.2 - 1.0 mm ²	24 - 20 AWG  22 - 20 AWG	0.2 - 1.0 mm ²	24 - 18 AWG  22-18 AWG
Protection	IP69	Type 4X / 6P	IP69	Type 4X / 6P

female

male



standard, straight

Color of coding	Marking of poles	female Part No.	male Part No.
■ black	2	41.021.4043.1	41.022.4043.1
■ light blue	2	41.021.4043.9	41.022.4043.9
■ pebble grey	2	41.021.4041.8	41.022.4041.8
■ slate grey	2	41.021.4041.4	41.022.4041.4

female

male



standard, straight

Color of coding	Marking of poles	female Part No.	male Part No.
■ black	3	41.031.4053.1	41.032.4053.1
■ light blue	3	41.031.4043.9	41.032.4043.9
■ pebble grey	3	41.031.4051.8	41.032.4051.8
■ slate grey	3	41.031.4041.4	41.032.4041.4

female

male



standard, straight

Color of coding	Marking of poles	female Part No.	male Part No.
■ black	4	41.041.4053.1	41.042.4053.1
■ light blue	4	41.041.4043.9	41.042.4043.9
■ pebble grey	4	41.041.4041.8	41.042.4041.8
■ slate grey	4	41.041.4041.4	41.042.4041.4

female

male



standard, straight

Color of coding	Marking of poles	female Part No.	male Part No.
■ black	5	41.051.4053.1	41.052.4053.1
■ light blue	5	41.051.4043.9	41.052.4043.9
■ pebble grey	5	41.051.4051.8	41.052.4051.8
■ slate grey	5	41.051.4041.4	41.052.4041.4

To order the part with an internal contact seal, replace '41' with '4L' in the part number.
Example 41.021.4041.4 > 4L.021.4041.4

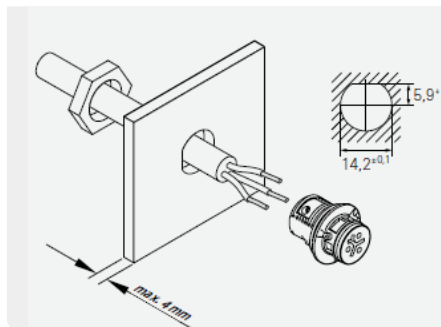



TWIST PROTECTION

The flat section on the the thread prevents the connector from rotating!

Product	Poles	D	d	Panel thickness
RST08i	2-3	14.2 ± 0.1	5.9 ± 0.1	4 mm
RST08i	4-5	17 ± 0.1	16 ± 0.1	4 mm

RST08, DISTRIBUTOR, 2-3-POLE

TECHNICAL DATA				
	2/3 Poles		4/5 Poles	
	IEC		IEC	
Voltage	250/400 V	400 V	250/400 V	400 V
Current	8 A		8 A	
Protection	IP69	Type 4X / 6P	IP69	Type 4X / 6P



distribution block 1I / 20, parallel connection, with fastening option

Color of coding	Poles	Part.No.
■ black	2	4L.020.1143.1
■ light blue	2	4L.020.1143.9
■ slate grey	2	4L.020.1141.4



distribution block 1I / 20, series connection, with fastening option

Color of coding	Poles	Part.No.
■ pebble grey	2	4L.020.1241.8



distribution block 1I / 30, parallel connection, with fastening option

Color of coding	Poles	Part.No.
■ black	2	4L.020.0143.1
■ light blue	2	4L.020.0143.9
■ slate grey	2	4L.020.0141.4



distribution block 1I / 30, series connection, with fastening option

Color of coding	Poles	Part.No.
■ pebble grey	2	4L.020.0241.8



distribution block 1I / 20, parallel connection, with fastening option

Color of coding	Poles	Part.No.
■ black	3	4L.030.1153.1
■ light blue	3	4L.030.1143.9
■ slate grey	3	4L.030.1141.4



distribution block 1I / 20, series connection, with fastening option

Color of coding	Poles	Part.No.
■ pebble grey	3	4L.030.1351.8



distribution block 1I / 30, parallel connection, with fastening option



Color of coding	Poles	Part.No.
■ black	3	4L.030.0153.1
■ light blue	3	4L.030.0143.9
■ slate grey	3	4L.030.0141.4



distribution block 1I / 30, series connection, with fastening option

Color of coding	Poles	Part.No.
■ pebble grey	3	4L.030.0351.8

RST08, DISTRIBUTOR, 4-5 POLE

TECHNICAL DATA				
	2/3 Poles		4/5 Poles	
	IEC		IEC	
Voltage	250/400 V	400 V	250/400 V	400 V
Current	8 A		8 A	
Protection	IP69	Type 4X / 6P	IP69	Type 4X / 6P



distribution block 1I / 2O, parallel connection, with fastening option

Color of coding	Poles	Part.No.
■ black	4	4L.040.1153.1
■ light blue	4	4L.040.1143.9
■ pebble grey	4	4L.040.1141.8
■ slate grey	4	4L.040.1141.4



distribution block 1I / 3O, parallel connection, with fastening option

Color of coding	Poles	Part.No.
■ black	4	4L.040.0153.1
■ light blue	4	4L.040.0143.9
■ pebble grey	4	4L.040.0141.8
■ slate grey	4	4L.040.0141.4



distribution block 1I / 2O, parallel connection, with fastening option

Color of coding	Poles	Part.No.
■ black	5	4L.050.1153.1
■ light blue	5	4L.050.1143.9
■ pebble grey	5	4L.050.1151.8
■ slate grey	5	4L.050.1141.4



distribution block 1I / 3O, parallel connection, with fastening option

Color of coding	Poles	Part.No.
■ black	5	4L.050.0153.1
■ light blue	5	4L.050.0143.9
■ pebble grey	5	4L.050.0151.8
■ slate grey	5	4L.050.0141.4

RST08, ACCESSORIES



cover piece for 2-/3-pole, captive against loss, for female

Color

■ black

Part No.

06.563.5053.1



cover piece for 2-/3-pole, captive against loss, for male

Color

■ black

Part No.

06.563.5153.1



cover piece for 4-/5-pole, captive against loss, for female

Color

■ black

Part No.

06.564.1553.1



cover piece for 4-/5-pole, captive against loss, for male

Color

■ black

Part No.

06.564.1653.1



screwdriver

Part No.

06.502.6300.0



allen key

Part No.

06.502.6100.0

RST® MINI

The small connectors
for confined spaces.

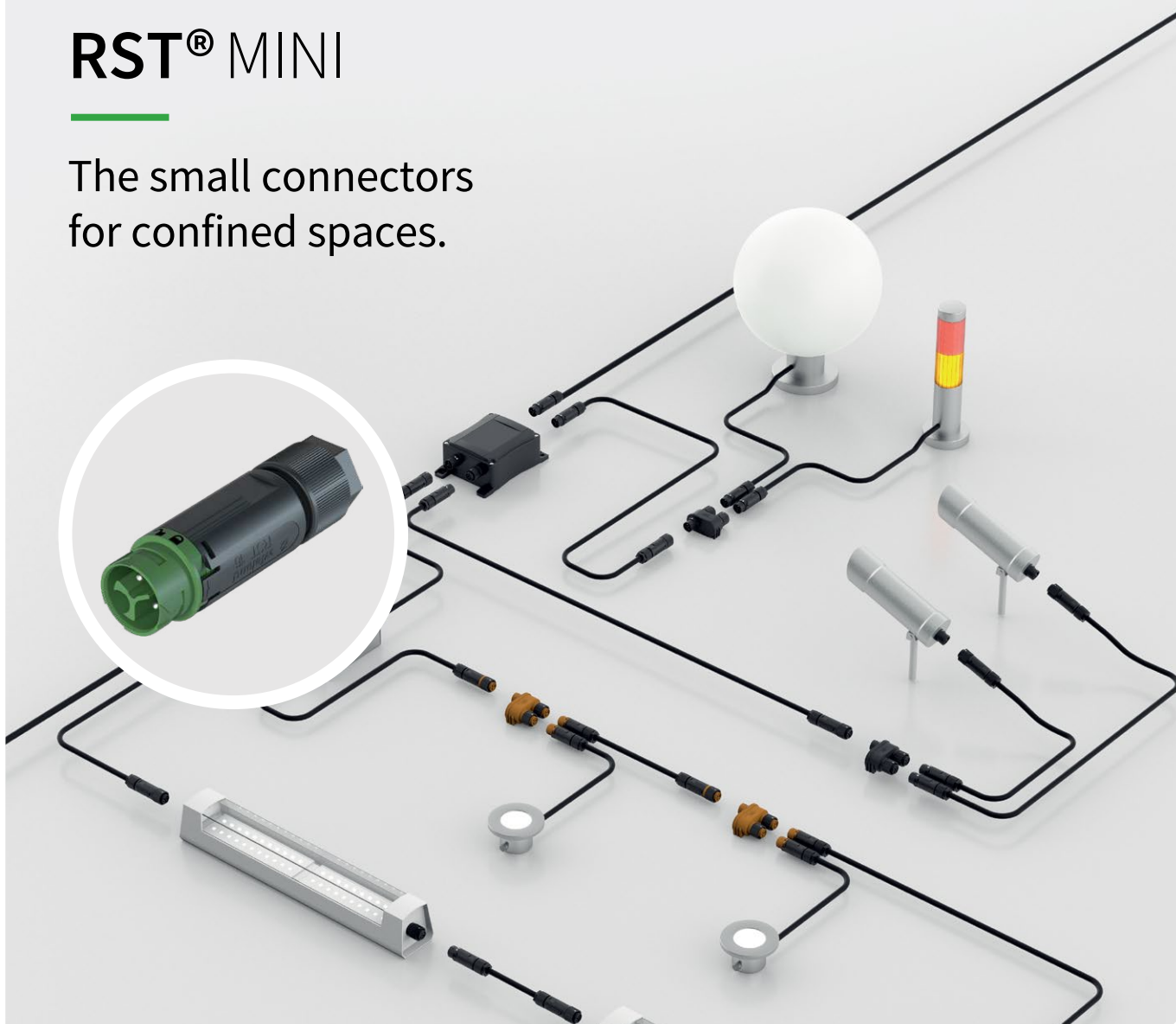

FEATURES

- + 2 to 5 poles
- + Rated up to 600 V and 16 A
- + Mechanical + color coding
- + Locking mechanism
- + Protection up to Type 4X / 6P

APPLICATIONS

- + Outdoor and high moisture environments
- + Small spaces
- + Great for luminaire connection

RST16i2



Mechanical coding (pole configuration based on female connector) **black** **light gray** **light blue** **turquoise** **signal brown**

Operating voltage (application) up to 600 V

RST16i3



Mechanical coding (pole configuration based on female connector) **black** **light gray** **leaf green** **light blue** **turquoise** **signal brown**

Operating voltage (application) up to 600 V

RST16i4



Mechanical coding (pole configuration based on female connector) **black** **light gray** **signal brown**

Operating voltage (application) up to 600 V

RST16i5





Mechanical coding (pole configuration based on female connector) **black** **light gray** **turquoise** **signal brown**

Operating voltage (application) up to 600 V

RST16I, CONNECTOR, 2-5 POLES

SCREW CONNECTION

TECHNICAL DATA				
	2/3 Poles		4/5 Poles	
	IEC		IEC	
Cable Ø	5.0 - 9.5 mm		7.1 - 13 mm	
Voltage	250/400 V	600 V	250/400 V	600 V
Current	16 A		16 A	
Wire Size	0.25 - 1.5 mm ²	24 - 14 AWG	0.25 - 2.5 mm ²	22 - 14 AWG
Protection	IP69	Type 4X	IP69	Type 4X/ 6P
Disconnect Under Load		300 Vac / 16 A		350 Vac / 16 A

female

male



straight, for cables

Ø 5-9.5 mm

Ø 7.1-13 mm

Color of coding	Poles	female	male	female	male
		Part no.	Part no.	Part.No.	Part no.
■ black	2	46.031.4554.1	46.032.4554.1	46.031.4454.1	46.032.4454.1
□ light grey	2	46.031.4554.0	46.032.4554.0	46.031.4454.0	46.032.4454.0
■ leaves green	2	46.031.4456.7	46.032.4456.7	46.031.4456.7	46.032.4456.7
■ light blue	2	46.031.4554.9	46.032.4554.9	46.031.4454.9	46.032.4454.9
■ turquoise blue	2	46.031.4551.6	46.032.4551.6	46.031.4451.6	46.032.4451.6
■ signal brown	2	46.031.4551.4	46.032.4551.4	46.031.4451.4	46.032.4451.4

female

male



straight, for cables

Ø 5-9.5 mm

Ø 7.1-13 mm

Color of coding	Poles	female	male	female	male
		Part no.	Part no.	Part.No.	Part no.
■ black	3	46.031.4553.1	46.032.4553.1	46.031.4453.1	46.032.4453.1
□ light grey	3	46.031.4553.0	46.032.4553.0	46.031.4453.0	46.032.4453.0
■ leaves green	3	46.031.4555.7	46.032.4555.7	46.031.4455.7	46.032.4455.7
■ light blue	3	46.031.4553.9	46.032.4553.9	46.031.4453.9	46.032.4453.9
■ turquoise blue	3	46.031.4550.6	46.032.4550.6	46.031.4450.6	46.032.4450.6
■ signal brown	3	46.031.4550.4	46.032.4550.4	46.031.4450.4	46.032.4450.4

female

male



straight, for cables

Ø 7.1-13 mm

Ø 10-14.5 mm

Color of coding	Poles	female	male	female	male
		Part no.	Part no.	Part no.	Part no.
■ black	4	46.051.4554.1	46.052.4554.1	46.051.4154.1	46.052.4154.1
□ light gray	4	46.051.4554.0	46.052.4554.0	46.051.4154.0	46.052.4154.0
■ signal brown	4	46.051.4551.4	46.052.4551.4	46.051.4151.4	46.052.4151.4

female

male



straight, for cables



Ø 7.1-13 mm

Ø 10-14.5 mm

Color of coding	Poles	female	male	female	male
		Part no.	Part no.	Part no.	Part no.
■ black	5	46.051.4553.1	46.052.4553.1	46.051.4153.1	46.052.4153.1
□ light grey	5	46.051.4553.0	46.052.4553.0	46.051.4153.0	46.052.4153.0
■ light blue	5	46.051.4553.9	46.052.4553.9	46.051.4153.9	46.052.4153.9
■ turquoise blue	5	46.051.4553.6	46.052.4553.6	46.051.4153.6	46.052.4153.6
■ signal brown	5	46.051.4550.4	46.052.4550.4	46.051.4150.4	46.052.4150.4

RST16I, DEVICE CONNECTOR, 2-5 POLES

SCREW CONNECTION

TECHNICAL DATA				
	2/3 Poles		4/5 Poles	
	IEC		IEC	
Thread Size	M16		M20	
Voltage	250/400 V	600 V	250/400 V	600 V
Current	16 A		16 A	
Wire Size	0.25 - 1.5 mm ²	24 - 14 AWG	0.25 - 2.5 mm ²	22 - 14 AWG
Protection	IP69	Type 4X	IP69	Type 4X / 6P
Disconnect Under Load		300 Vac / 16 A		350 Vac / 16 A

female

male



standard, straight, M16

Color of coding	Poles	female Part no.	male Part no.
■ black	2	46.031.5054.1	46.032.5054.1
□ light gray	2	46.031.5054.0	46.032.5054.0
■ light blue	2	46.031.5054.9	46.032.5054.9
■ turquoise blue	2	46.031.5051.6	46.032.5051.6
■ signal brown	2	46.031.5051.4	46.032.5051.4

female

male



standard, straight, M16

Color of coding	Poles	female Part no.	male Part no.
■ black	3	46.031.5053.1	46.032.5053.1
□ light gray	3	46.031.5053.0	46.032.5053.0
■ leaves green	3	46.031.5055.7	46.032.5055.7
■ light blue	3	46.031.5053.9	46.032.5053.9
■ turquoise blue	3	46.031.5050.6	46.032.5050.6
■ signal brown	3	46.031.5050.4	46.032.5050.4

female

male



standard, straight, M20

Color of coding	Poles	female Part no.	male Part no.
■ black	4	46.051.5054.1	46.052.5054.1
□ light gray	4	46.051.5054.0	46.052.5054.0
■ signal brown	4	46.051.5051.4	46.052.5051.4

female

male



standard, straight, M20

Color of coding	Poles	female Part no.	male Part no.
■ black	5	46.051.5053.1	46.052.5053.1
□ light gray	5	46.051.5053.0	46.052.5053.0
■ light blue	5	46.051.5053.9	46.052.5053.9
■ turquoise blue	5	46.051.5053.6	46.052.5053.6
■ signal brown	5	46.051.5050.4	46.052.5050.4

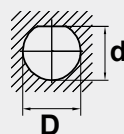
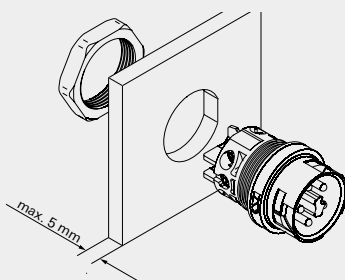



TWIST PROTECTION

The flat section on the the thread prevents the connector from rotating!

Product	Hole Size	D	d	Panel thickness
RST16i	M16	16.2 ± 0.1	14.6 ± 0.1	5 mm
RST16i	M20	20.4 ± 0.1	19.4 ± 0.1	5 mm

RST16I, DISTRIBUTOR, 2-5 POLES

TECHNICAL DATA				
	2/3 Poles		4/5 Poles	
	IEC		IEC	
Voltage	250/400 V	600 V	250/400 V	600 V
Current	16 A		16 A	
Protection	IP69	Type 4X	IP69	Type 4X / 6P
Disconnect Under Load		300 Vac / 16 A		350 Vac / 16 A



distribution block 1I / 2O, parallel connection, with fastening option to 06.562.5853.0 / 06.562.5853.1

Color of coding	Poles	Part no.
■ black	2	46.030.1254.1
□ light grey	2	46.030.1254.0
■ light blue	2	46.030.1254.9
■ turquoise blue	2	46.030.1251.6
■ signal brown	2	46.030.1251.4



distribution block 1I / 2O, parallel connection, with fastening option to mounting plate 06.562.5853.0 / 06.562.5853.1

Color of coding	Poles	Part no.
■ black	3	46.030.1253.1
□ light grey	3	46.030.1253.0
■ leaves green	3	46.030.1255.7
■ light blue	3	46.030.1253.9
■ turquoise blue	3	46.030.1250.6
■ signal brown	3	46.030.1250.4



distribution block 1I / 2O, parallel connection, with fastening option to 06.562.5853.0 / 06.562.5853.1

Color of coding	Poles	Part no.
■ black	4	46.050.1254.1
□ light grey	4	46.050.1254.0
■ signal brown	4	46.050.1251.4



distribution block 1I / 2O, parallel connection, with fastening option to mounting plate 06.562.5853.0 / 06.562.5853.1

Color of coding	Poles	Part no.
■ black	5	46.050.1253.1
□ light grey	5	46.050.1253.0
■ light blue	5	46.050.1253.9
■ turquoise blue	5	46.050.1253.6
■ signal brown	5	46.050.1250.4



Custom junction boxes in 2-5 poles available on request. Please contact us for part numbers and options.

RST16, ACCESSORIES



Cover piece, tethered

Color	Poles	for male	for female
		Part no.	Part no.
■ black	2/3	06.563.8953.1	06.563.8753.1
□ light gray	2/3	06.563.8953.0	06.563.8753.0
■ black	4/5	06.563.9353.1	06.563.9153.1
□ light gray	4/5	06.563.9353.0	06.563.9153.0



Cover piece, untethered

Color	Poles	for male	for female
		Part no.	Part no.
■ black	2/3	06.563.8853.1	06.563.8653.1
□ light gray	2/3	06.563.8853.0	06.563.8653.0
■ black	4/5	06.563.9253.1	06.563.9053.1
□ light gray	4/5	06.563.9253.0	06.563.9053.0



Sealing ring

Color	Ø size	Part no.
■ black	5.0 - 9.5 mm	06.562.0583.0
■ black	7.1 - 13 mm	06.561.8383.0



Mounting plate, for distribution terminal block

Color	Part no.
■ black	06.562.5853.1
□ light gray	06.562.5853.0



Sample case, RST16i3

Part no.
99.674.0000.0



Sample case, RST16i5

Part no.
99.675.0000.0

MOLA® DEVICE CONNECTOR

The MOLA® device connectors are compatible with the proven RST® MINI system, which provides additional components such as plug connectors, pre-assembled cables, distributors and device connectors with screw technology. This device connector is ideal for applications including, daisy chain luminaires and automated (robotic) wire harness assembly.

The MOLA® device connectors offer innovative, modular solutions with spring clamp technology, compatible with RST® MINI. Designed for quick, secure, and flexible IP-protected installations, they are ideal for lighting, motors, heating, and more. These connectors are optimized for luminaires, feature high protection ratings, and allow easy installation and handling. Available in multiple configurations, MOLA® connectors also support automatic robotic wiring.



 **UL** US
600 V, 16 A, 18-14 AWG

MOLA® – THE BENEFITS AT A GLANCE

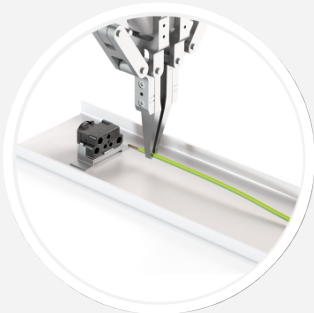

AUTOMATIC WIRING

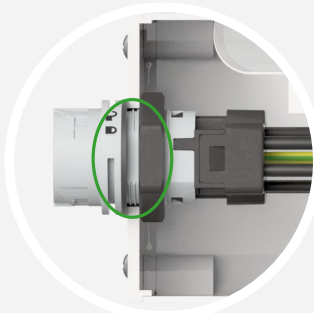

FOR 20 MM BUSHINGS



MODULAR STRUCTURE

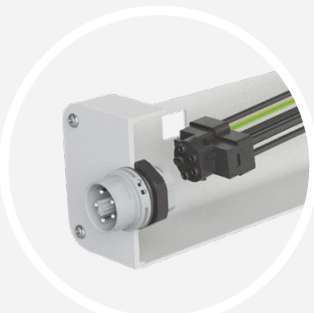

**SEPARATE PREASSEMBLY –
SIMPLY PLUG IT**

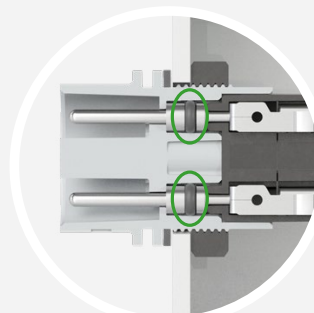

**ADDITIONAL
CONTACT SEAL**

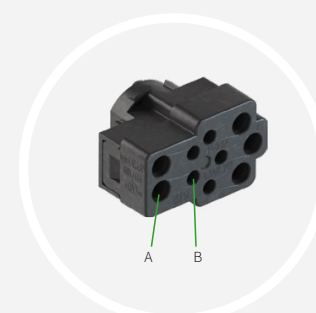

**REPLACES INTERNAL
TERMINAL**

MOLA® - THE LUMINAIRE PRO

MOLA® can be used for luminaires with through-wiring as well as for point source luminaires.

EXAMPLE THROUGH-WIRING 5-POLE

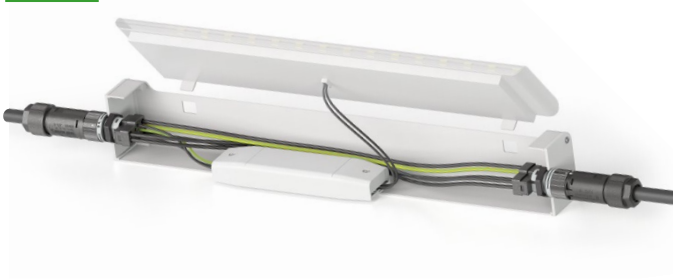

EXAMPLE OF 3-POLE STUB WIRING



MORE SAFETY WITH INTERNAL CONTACT SEAL

Variants with additional contact seal (longitudinal seal) are also available as an option. They prevent the ingress of moisture into the contacts due to condensation or damaged cables.

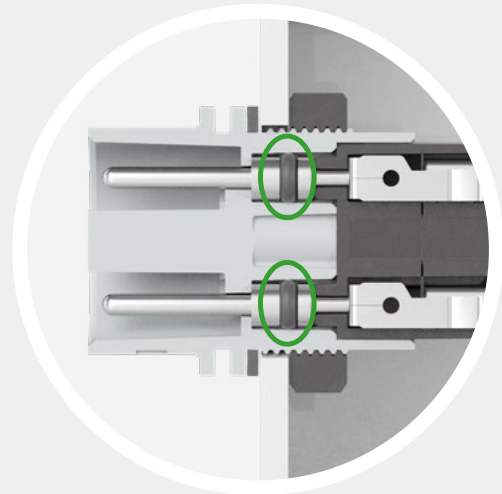

PRODUCT VIDEO

The product video for the MOLA® device connectors of the RST® MINI series can be found on our YouTube channel.

Scan the QR code – watch the video.



MOLA®
Innovative, modular device
connector compatible with RST® MINI.

RST® CLASSIC

The all-purpose connector with the most extensive range.

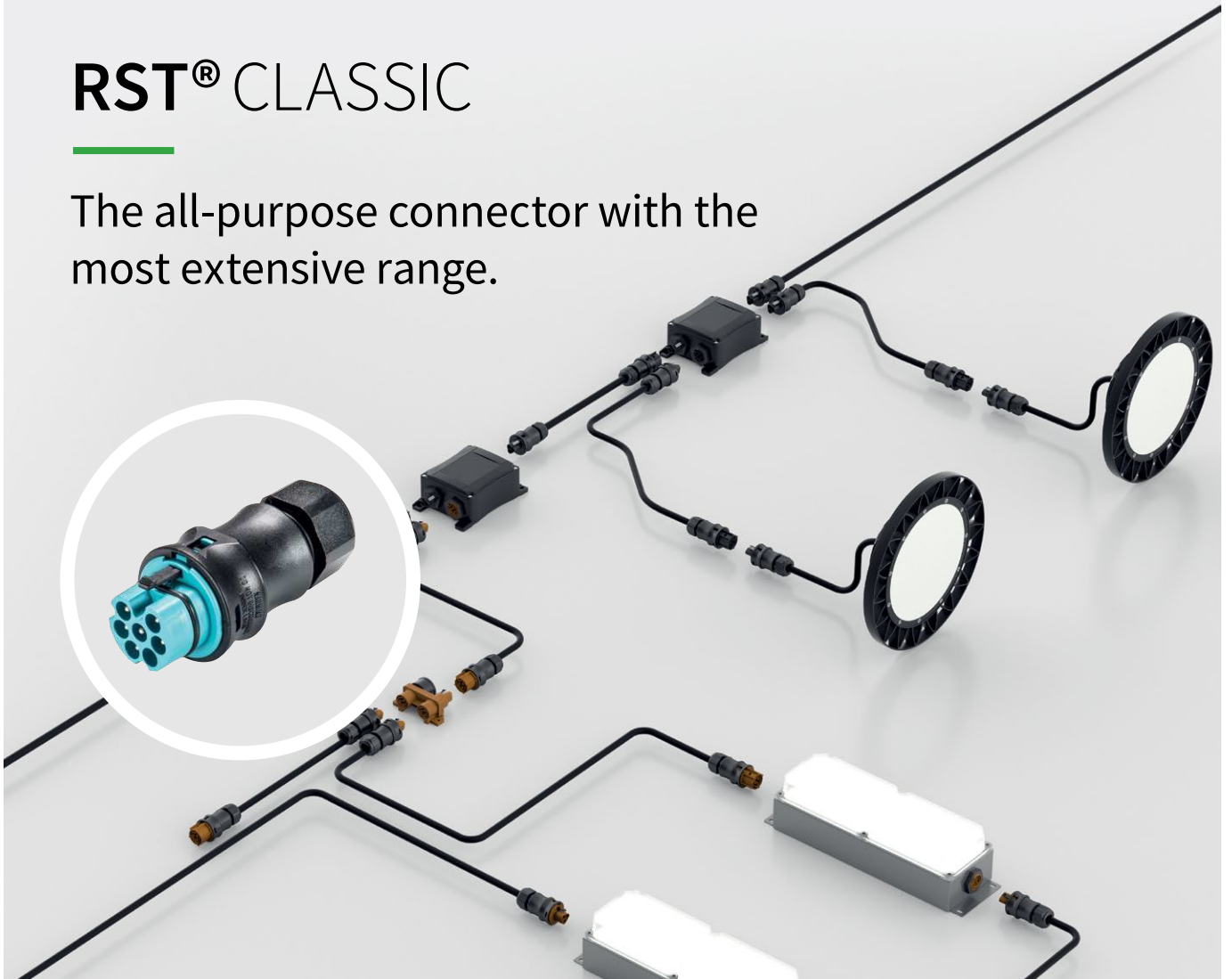

FEATURES

- + 2 to 7 poles
- + Rated up to 20 A and 600 V
- + 25 A option
- + Mechanical + color coding
- + Optional integrated contact seal on 6 and 7-pole versions
- + Protection up to Type 4X / 6P
- + Screw and spring contacts for easy field installation
- + Crimp contacts also available

APPLICATIONS

- + Outdoor and high-moisture environments
- + Higher electrical loads
- + Ideal for greenhouses and vertical farms
- + Anywhere fast changes and modular designs are need
- + **Variant available for use in Hazardous locations (compliant with either ATEX, IEC Ex, CSA Class 1 Zone 2 requirements) and extra-low voltage for LED technology**
- + For high volume applications

RST20i2



Mechanical coding (pole configuration based on female connector)	black	light gray	pebble gray	signal brown
Operating voltage (application)	up to 600 V			

RST20i3



Mechanical coding (pole configuration based on female connector)	black	light gray	leaf green	light blue	signal brown
Operating voltage (application)	up to 600 V				

RST20i4



Mechanical coding (pole configuration based on female connector)	black	light gray	signal brown
Operating voltage (application)	up to 600 V		

RST20i5



Mechanical coding (pole configuration based on female connector)	black	light gray	turquoise	light blue	yellow	signal brown
Operating voltage (application)	up to 600 V					

RST20i6



Mechanical coding (pole configuration based on female connector)	turquoise
Operating voltage (application)	up to 600 V

RST20i7



Mechanical coding (pole configuration based on female connector)	black	light gray	turquoise	light blue
Operating voltage (application)	up to 600 V			

RST25i3





Mechanical coding (pole configuration based on female connector)	Concrete gray
Operating voltage (application)	up to 600 V

RST25i5



Mechanical coding (pole configuration based on female connector)	Concrete gray
Operating voltage (application)	up to 600 V

RST20I, CONNECTOR, 2/3 POLES

TECHNICAL DATA				
	2/3 Poles (screw)		2/3 Poles (spring)	
	IEC		IEC	
Cable Ø	6 - 10 mm / 10 - 14 mm / 13 mm - 18 mm / 8 mm - 12 mm (upon request)			
Voltage	250/400 V	600 V	250/400 V	600 V
Current	20 A	20 A	20 A	20 A (USA) 15 A (Canada)
Wire Size	0.75 - 6 mm ²	16 - 10 AWG  16-12 AWG	0.50 - 2.5mm ²	20 - 14 AWG
Protection	IP69	Type 4X / 6P	IP69	Type 4X/6P
Disconnect Under Load		400 Vac / 20 A (USA) 350 Vac / 20 A (Canada)		N/A

female



male



Straight, for cables Ø 6-10 mm

Color of coding	Poles	Screw connection		Spring clamp connection	
		female	male	female	male
■ black	2	96.021.4053.1	96.022.4053.1	96.021.0053.1	96.022.0053.1
□ light gray	2	96.021.4053.0	96.022.4053.0	96.021.0053.0	96.022.0053.0
■ pebble gray	2	96.021.4050.8	96.022.4050.8	96.021.0050.8	96.022.0050.8
■ signal brown	2	96.021.4051.4	96.022.4051.4	96.021.0051.4	96.022.0051.4

Crimp contact versions are also available.

female



male



Straight, for cables Ø 10-14 mm

Color of coding	Poles	Screw connection		Spring clamp connection	
		female	male	female	male
■ black	2	96.021.4153.1	96.022.4153.1	96.021.0153.1	96.022.0153.1
□ light gray	2	96.021.4153.0	96.022.4153.0	96.021.0153.0	96.022.0153.0
■ pebble gray	2	96.021.4150.8	96.022.4150.8	96.021.0150.8	96.022.0150.8
■ signal brown	2	96.021.4151.4	96.022.4151.4	96.021.0151.4	96.022.0151.4

female



male



Straight, for cables Ø 6-10 mm

Color of coding	Poles	Screw connection		Spring clamp connection	
		female	male	female	male
■ black	3	96.031.4053.1	96.032.4053.1	96.031.0053.1	96.032.0053.1
□ light gray	3	96.031.4053.0	96.032.4053.0	96.031.0053.0	96.032.0053.0
■ leaves green	3	96.031.4055.7	96.032.4055.7	96.031.0055.7	96.032.0055.7
■ light blue	3	96.031.4053.9	96.032.4053.9	96.031.0053.9	96.032.0053.9
■ signal brown	3	96.031.4051.4	96.032.4051.4	96.031.0051.4	96.032.0051.4

female



male



Straight, for cables Ø 10-14 mm

Color of coding	Poles	Screw connection		Spring clamp connection	
		female	male	female	male
■ black	3	96.031.4153.1	96.032.4153.1	96.031.0153.1	96.032.0153.1
□ light gray	3	96.031.4153.0	96.032.4153.0	96.031.0153.0	96.032.0153.0
■ leaves green	3	96.031.4155.7	96.032.4155.7	96.031.0155.7	96.032.0155.7
■ light blue	3	96.031.4153.9	96.032.4153.9	96.031.0153.9	96.032.0153.9
■ signal brown	3	96.031.4151.4	96.032.4151.4	96.031.0151.4	96.032.0151.4

female



male





Straight, for cables Ø 13-18 mm

Color of coding	Poles	Screw connection		Spring clamp connection	
		female	male	female	male
■ black	3	96.031.4553.1	96.032.4553.1		
□ light gray	3	96.031.4553.0	96.032.4553.0		
■ leaves green	3	96.031.4555.7	96.032.4555.7	96.031.0555.7	96.032.0555.7
■ light blue	3	96.031.4553.9	96.032.4553.9	96.031.0553.9	96.032.0553.9

RST20I, CONNECTOR, 2/3 POLES

TECHNICAL DATA

	2/3 Poles (screw)		2/3 Poles (spring)	
	IEC		IEC	
Cable Ø	6 - 10 mm / 10 - 14 mm			
Voltage	250/400 V	600 V	250/400 V	600 V
Current	20 A	20 A	20 A	20 A (USA) 15 A (Canada)
Wire Size	0.75 - 6 mm ²	16 - 10 AWG  16-12 AWG	0.50 - 2.5mm ²	20 - 14 AWG
Protection	IP69	Type 4X / 6P	IP69	Type 4X/6P
Disconnect Under Load		400 Vac / 20 A (USA) 350 Vac / 20 A (Canada)		N/A

female



male



angled 90°, for cables Ø 6-10 mm

Color of coding	Poles	Screw Connection		Spring Clamp Connection	
		female	male	female	male
■ black	2	96.023.4053.1	96.024.4053.1	96.023.0053.1	96.024.0053.1
□ light gray	2	96.023.4053.0	96.024.4053.0	96.023.0053.0	96.024.0053.0
■ pebble gray	2	96.023.4050.8	96.024.4050.8	96.023.0050.8	96.024.0050.8
■ signal brown	2	96.023.4051.4	96.024.4051.4	96.023.0051.4	96.024.0051.4

female



male



angled 90°, for cables Ø 10-14 mm

Color of coding	Poles	Screw connection		Spring clamp connection	
		female	male	female	male
■ black	2	96.023.4153.1	96.024.4153.1	96.023.0153.1	96.024.0153.1
□ light gray	2	96.023.4153.0	96.024.4153.0	96.023.0153.0	96.024.0153.0
■ pebble gray	2	96.023.4150.8	96.024.4150.8	96.023.0150.8	96.024.0150.8
■ signal brown	2	96.023.4151.4	96.024.4151.4	96.023.0151.4	96.024.0151.4

female



male



angled 90°, for cables Ø 6-10 mm

Color of coding	Poles	Screw connection		Spring clamp connection	
		female	male	female	male
■ black	3	96.033.4053.1	96.034.4053.1	96.033.0053.1	96.034.0053.1
□ light gray	3	96.033.4053.0	96.034.4053.0	96.033.0053.0	96.034.0053.0
■ leaves green	3	96.033.4055.7	96.034.4055.7	96.033.0055.7	96.034.0055.7
■ light blue	3	96.033.4053.9	96.034.4053.9	96.033.0053.9	96.034.0053.9
■ signal brown	3	96.033.4051.4	96.034.4051.4	96.033.0051.4	96.034.0051.4

female





male



angled 90°, for cables Ø 10-14 mm

Color of coding	Poles	Screw connection		Spring clamp connection	
		female	male	female	male
■ black	3	96.033.4153.1	96.034.4153.1	96.033.0153.1	96.034.0153.1
□ light gray	3	96.033.4153.0	96.034.4153.0	96.033.0153.0	96.034.0153.0
■ leaves green	3	96.033.4155.7	96.034.4155.7	96.033.0155.7	96.034.0155.7
■ light blue	3	96.033.4153.9	96.034.4153.9	96.033.0153.9	96.034.0153.9
■ signal brown	3	96.033.4151.4	96.034.4151.4	96.033.0151.4	96.034.0151.4

RST20i, DEVICE CONNECTOR, M20, 2/3 POLES

TECHNICAL DATA				
	2/3 Poles (screw)		2/3 Poles (spring)	
	IEC		IEC	
Thread Size	M20			
Voltage	250/400 V	600 V	250/400 V	600 V
Current	20 A	20 A	20 A	20 A (USA) 15 A (Canada)
Wire Size	0.75 - 6 mm ²	16 - 10 AWG  16-12 AWG	0.50 - 2.5mm ²	20 - 14 AWG
Protection	IP69	Type 4X / 6P	IP69	Type 4X/6P
Disconnect Under Load		400 Vac / 20 A (USA) 350 Vac / 20 A (Canada)		N/A

female

male



modular, straight

Color of coding	Poles	Screw connection		Spring clamp connection	
		female	male	female	male
■ black	2	96.021.6053.1	96.022.6053.1	96.021.2053.1	96.022.2053.1
□ light gray	2	96.021.6053.0	96.022.6053.0	96.021.2053.0	96.022.2053.0
■ pebble gray	2	96.021.6050.8	96.022.6050.8	96.021.2050.8	96.022.2050.8
■ signal brown	2	96.021.6051.4	96.022.6051.4	96.021.2051.4	96.022.2051.4

female

male



modular, angled 90°

Color of coding	Poles	Screw connection		Spring clamp connection	
		female	male	female	male
■ black	2	96.023.6053.1	96.024.6053.1	96.023.2053.1	96.024.2053.1
□ light gray	2	96.023.6053.0	96.024.6053.0	96.023.2053.0	96.024.2053.0
■ pebble gray	2	96.023.6050.8	96.024.6050.8	96.023.2050.8	96.024.2050.8
■ signal brown	2	96.023.6051.4	96.024.6051.4	96.023.2051.4	96.024.2051.4

female

male



modular, straight

Color of coding	Poles	Screw connection		Spring clamp connection	
		female	male	female	male
■ black	3	96.031.6053.1	96.032.6053.1	96.031.2053.1	96.032.2053.1
□ light gray	3	96.031.6053.0	96.032.6053.0	96.031.2053.0	96.032.2053.0
■ leaves green	3	96.031.6055.7	96.032.6055.7	96.031.2055.7	96.032.2055.7
■ light blue	3	96.031.6053.9	96.032.6053.9	96.031.2053.9	96.032.2053.9
■ signal brown	3	96.031.6051.4	96.032.6051.4	96.031.2051.4	96.032.2051.4

female

male



modular, angled 90°

Color of coding	Poles	Screw connection		Spring clamp connection	
		female	male	female	male
■ black	3	96.033.6053.1	96.034.6053.1	96.033.2053.1	96.034.2053.1
□ light gray	3	96.033.6053.0	96.034.6053.0	96.033.2053.0	96.034.2053.0
■ leaves green	3	96.033.6055.7	96.034.6055.7	96.033.2055.7	96.034.2055.7
■ light blue	3	96.033.6053.9	96.034.6053.9	96.033.2053.9	96.034.2053.9
■ signal brown	3	96.033.6051.4	96.034.6051.4	96.033.2051.4	96.034.2051.4

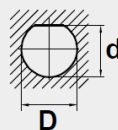
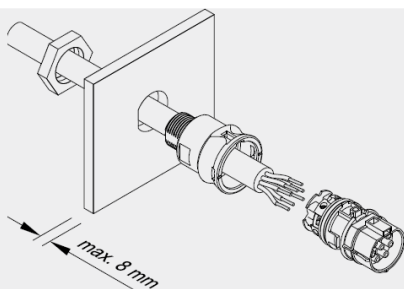

TWIST PROTECTION

The flat section on the the thread prevents the connector from rotating!

Product	Hole Size	D	d	Panel thickness
RST20i	M20	20.4 ^{-0.2}	19.0 ^{-0.2}	8 mm
RST20i	M25	25.4 ^{-0.2}	23.9 ^{-0.2}	8 mm

RST20I, DEVICE CONNECTOR, M25, 2/3 POLES

TECHNICAL DATA				
	2/3 Poles (screw)		2/3 Poles (spring)	
	IEC	UL _{IS}	IEC	UL _{IS}
Thread Size	M25			
Voltage	250/400 V	600 V	250/400 V	600 V
Current	20 A	20 A	20 A	20 A (USA) 15 A (Canada)
Wire Size	0.75 - 6 mm ²	16 - 10 AWG 16-12 AWG	0.50 - 2.5mm ²	20 - 14 AWG
Protection	IP69	Type 4X / 6P	IP69	Type 4X/6P
Disconnect Under Load		400 Vac / 20 A (USA) 350 Vac / 20 A (Canada)		N/A

female

male



Standard, straight

Color of coding	Poles	Screw connection		Spring clamp connection	
		female	male	female	male
■ black	2	96.021.5053.1	96.022.5053.1	96.021.1053.1	96.022.1053.1
□ light gray	2	96.021.5053.0	96.022.5053.0	96.021.1053.0	96.022.1053.0
■ pebble gray	2	96.021.5050.8	96.022.5050.8	96.021.1050.8	96.022.1050.8
■ signal brown	2	96.021.5051.4	96.022.5051.4	96.021.1051.4	96.022.1051.4

female

male



Modular, angled 90°

Color of coding	Poles	Screw connection		Spring clamp connection	
		female	male	female	male
■ black	2	96.023.6253.1	96.024.6253.1	96.023.2253.1	96.024.2253.1
□ light gray	2	96.023.6253.0	96.024.6253.0	96.023.2253.0	96.024.2253.0
■ pebble gray	2	96.023.6250.8	96.024.6250.8	96.023.2250.8	96.024.2250.8
■ signal brown	2	96.023.6251.4	96.024.6251.4	96.023.2251.4	96.024.2251.4

female

male



Standard, straight

Color of coding	Poles	Screw connection		Spring clamp connection	
		female	male	female	male
■ black	3	96.031.5053.1	96.032.5053.1	96.031.1053.1	96.032.1053.1
□ light gray	3	96.031.5053.0	96.032.5053.0	96.031.1053.0	96.032.1053.0
■ leaves green	3	96.031.5055.7	96.032.5055.7	96.031.1055.7	96.032.1055.7
■ light blue	3	96.031.5053.9	96.032.5053.9	96.031.1053.9	96.032.1053.9
■ signal brown	3	96.031.5051.4	96.032.5051.4	96.031.1051.4	96.032.1051.4

female

male



Modular, angled 90°

Color of coding	Poles	Screw connection		Spring clamp connection	
		female	male	female	male
■ black	3	96.033.6253.1	96.034.6253.1	96.033.2253.1	96.034.2253.1
□ light gray	3	96.033.6253.0	96.034.6253.0	96.033.2253.0	96.034.2253.0
■ leaves green	3	96.033.6255.7	96.034.6255.7	96.033.2255.7	96.034.2255.7
■ light blue	3	96.033.6253.9	96.034.6253.9	96.033.2253.9	96.034.2253.9
■ signal brown	3	96.033.6251.4	96.034.6251.4	96.033.2251.4	96.034.2251.4

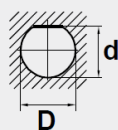
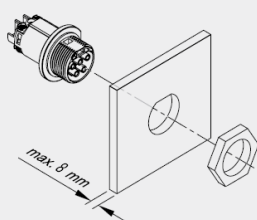

TWIST PROTECTION

The flat section on the the thread prevents the connector from rotating!

Product	Hole Size	D	d	Panel thickness
RST20i	M20	20.4 ^{-0.2}	19.0 ^{-0.2}	8 mm
RST20i	M25	25.4 ^{-0.2}	23.9 ^{-0.2}	8 mm

RST20I, DISTRIBUTOR, 2/3 POLES

TECHNICAL DATA

Rated current:	20 A	Lockable:	self-locking (unlocking by tool)
Degree of protection (IP):	IP66/68 (3m;2h) / IP69 Type 4X / 6P	Contact us for part numbers and additional options.	



distribution block 1I / 30, parallel connection

Color of coding	Poles	With fastening option	Without fastening option
■ black	2	96.020.0153.1	96.020.0253.1
□ light gray	2	96.020.0153.0	96.020.0253.0
■ pebble gray	2	96.020.0150.8	96.020.0250.8
■ signal brown	2	96.020.0151.4	96.020.0251.4



distribution block 1I / 30, parallel connection, with fastening option

Color of coding	Poles	With fastening option	Without fastening option
■ black	3	96.030.0153.1	96.030.0253.1
□ light gray	3	96.030.0153.0	96.030.0253.0
■ leaves green	3	96.030.0155.7	96.030.0255.7
■ light blue	3	96.030.0153.9	
■ signal brown	3	96.030.0151.4	96.030.0251.4



multi-distribution unit 1I / 70, parallel connection, with fastening option

Color of coding	Poles	Part no.
■ black	2/3	Distribution units made to specifications.
■ signal brown	2/3	Please contact us for options.



compact distributor 1I / 30, parallel connection, with fastening option

Color of coding	Poles	Part no.
■ black	2/3	Distribution units made to specifications. Please contact us for options.

RST20I, CONNECTOR, 4/5 POLES

SCREW CONNECTION

TECHNICAL DATA		
	4/5 Poles	
	IEC	
Thread Size	M20	
Voltage	250/400 V	600 V
Current	20 A	20 A
Wire Size	0.75 - 4 mm ²	18 - 14 AWG
Protection	IP69	Type 4X / 6P
Disconnect Under Load	350 Vac / 20 A (Canada)	

female

male



straight, for cables Ø 6-10 mm

Color of coding	Poles
■ black	4
□ light gray	4
■ signal brown	4

female

male

Part no.	Part no.
96.041.4053.1	96.042.4053.1
96.041.4053.0	96.042.4053.0
96.041.4051.4	96.042.4051.4

Color of coding	Poles
■ black	5
□ light gray	5
■ light blue	5
■ turquoise blue	5
■ yellow	5
■ signal brown	5

female

male

Part no.	Part no.
96.051.4053.1	96.052.4053.1
96.051.4053.0	96.052.4053.0
96.051.4053.9	96.052.4053.9
96.051.4053.6	96.052.4053.6
96.051.4053.2	96.052.4053.2
96.051.4051.4	96.052.4051.4

female

male



straight, for cables Ø 10-14 mm

Color of coding	Poles
■ black	4
□ light gray	4
■ signal brown	4

female

male

Part no.	Part no.
96.041.4153.1	96.042.4153.1
96.041.4153.0	96.042.4153.0
96.041.4151.4	96.042.4151.4

Color of coding	Poles
■ black	5
□ light gray	5
■ light blue	5
■ turquoise blue	5
■ yellow	5
■ signal brown	5

female

male

Part no.	Part no.
96.051.4153.1	96.052.4153.1
96.051.4153.0	96.052.4153.0
96.051.4153.9	96.052.4153.9
96.051.4153.6	96.052.4153.6
96.051.4153.2	96.052.4153.2
96.051.4151.4	96.052.4151.4

female

male



straight, for cables Ø 13-18 mm

Color of coding	Poles
■ black	4
□ light gray	4

female

male

Part no.	Part no.
96.041.4553.1	96.042.4553.1
96.041.4553.0	96.042.4553.0

Color of coding	Poles
■ black	5
□ light gray	5
■ light blue	5
■ turquoise blue	5
■ yellow	5
■ signal brown	5

female

male

Part no.	Part no.
96.051.4553.1	96.052.4553.1
96.051.4553.0	96.052.4553.0
96.051.4553.9	96.052.4553.9
96.051.4553.6	96.052.4553.6
96.051.4553.2	96.052.4553.2
96.051.4551.4	96.052.4551.4

female



male

**angled 90°, for cables Ø 6-10 mm**

Color of coding	Poles
■ black	4
□ light gray	4

female

Part no.
96.143.0053.1
96.143.0053.0

Color of coding	Poles
■ black	5
□ light gray	5
■ light blue	5
■ turquoise blue	5
■ signal brown	5

female

Part no.	male Part no.
96.053.4053.1	96.054.4053.1
96.053.4053.0	96.054.4053.0
96.053.4053.9	96.054.4053.9
96.053.4053.6	96.054.4053.6
96.053.4051.4	96.054.4051.4

female



male

**angled 90°, for cables Ø 10-14 mm**

Color of coding	Poles
■ black	4
□ light gray	4

female

Part no.	male Part no.
96.143.0153.1	96.144.0153.1
96.143.0153.0	96.144.0153.0

Color of coding	Poles
■ black	5
□ light gray	5
■ light blue	5
■ turquoise blue	5
■ signal brown	5

female

Part no.	male Part no.
96.053.4153.1	96.054.4153.1
96.053.4153.0	96.054.4153.0
96.053.4153.9	96.054.4153.9
96.053.4153.6	96.054.4153.6
96.053.4151.4	96.054.4151.4

RST20I, DEVICE CONNECTOR, M20, 4/5 POLES

SCREW CONNECTION

female



male

**modular, straight**

Color of coding	Poles
■ black	4
□ light gray	4
■ signal brown	4

female

Part no.	male Part no.
96.041.6053.1	96.042.6053.1
96.041.6053.0	96.042.6053.0
96.041.6051.4	96.042.6051.4

Color of coding	Poles
■ black	5
□ light gray	5
■ light blue	5
■ turquoise blue	5
■ signal brown	5

female

Part no.	male Part no.
96.051.6053.1	96.052.6053.1
96.051.6053.0	96.052.6053.0
96.051.6053.9	96.052.6053.9
96.051.6053.6	96.052.6053.6
96.051.6051.4	96.052.6051.4

female



male

**modular, angled 90°**

Color of coding	Poles
■ black	4
□ light gray	4

female

Part no.	male Part no.
96.043.6053.1	96.044.6053.1
96.043.6053.0	96.044.6053.0

Color of coding	Poles
■ black	5
□ light gray	5
■ light blue	5
■ turquoise blue	5
■ signal brown	5

female

Part no.	male Part no.
96.053.6053.1	96.054.6053.1
96.053.6053.0	96.054.6053.0
96.053.6053.9	96.054.6053.9
96.053.6053.6	96.054.6053.6
96.053.6051.4	96.054.6051.4

RST20I4, DEVICE CONNECTOR, M25, 4/5 POLES

SCREW CONNECTION

TECHNICAL DATA		
	4/5 Poles	
	IEC	
Thread Size	M25	
Voltage	250/400 V	600 V
Current	20 A	20 A
Wire Size	0.75 - 4 mm ²	18 - 14 AWG
Protection	IP69	Type 4X / 6P
Disconnect Under Load	350 Vac / 20 A (Canada)	

female



male



standard, straight

Color of coding	Poles	female Part no.	male Part no.
■ black	4	96.041.5053.1	96.042.5053.1
□ light gray	4	96.041.5053.0	96.042.5053.0
■ signal brown	4	96.041.5051.4	96.042.5051.4

standard, straight

Color of coding	Poles	female Part no.	male Part no.
■ black	5	96.051.5053.1	96.052.5053.1
□ light gray	5	96.051.5053.0	96.052.5053.0
■ light blue	5	96.051.5053.9	96.052.5053.9
■ turquoise blue	5	96.051.5053.6	96.052.5053.6
■ signal brown	5	96.051.5051.4	96.052.5051.4

female



male



modular, angled 90°

Color of coding	Poles	female Part no.	male Part no.
■ black	4	96.043.6253.1	96.044.6253.1
□ light gray	4	96.043.6253.0	96.044.6253.0
■ signal brown	4	96.043.6251.4	96.044.6251.4

modular, angled 90°

Color of coding	Poles	female Part no.	male Part no.
■ black	5	96.053.6253.1	96.054.6253.1
□ light gray	5	96.053.6253.0	96.054.6253.0
■ light blue	5	96.053.6253.9	96.054.6253.9
■ turquoise blue	5	96.053.6253.6	96.054.6253.6
■ signal brown	5	96.053.6251.4	96.054.6251.4

RST20I, DISTRIBUTOR, 4/5 POLES

TECHNICAL DATA			
Rated current:	20 A	Lockable:	self-locking (unlocking by tool)
Degree of protection (IP):	IP66/68 (3m;2h) / IP69	Additional technical data, see facts & data.	
	Type 4X / 6P		



compact distributor 11 / 30, parallel connection, with fastening option

Color of coding	Poles	Part no.
■ black	4/5	Distribution units made to specifications. Please contact us for options.



compact distributor 11 / 20, parallel connection, with fastening option

Color of coding	Poles	Part no.
■ black	5	Distribution units made to specifications. Please contact us for options.

RST20I CONNECTOR, 6/7 POLES

SCREW CONNECTION

Optional **water seals** on individual contacts for added protection when unmated. (Refer to page 23).

TECHNICAL DATA		
6/7 Poles (screw)		
	IEC	
Cable Ø	6 - 10 mm / 10 - 14 mm / 13 - 18 mm	
Voltage	250/400 V	600 V
Current	3 x 20 A + 4 x 5 A	3 x 20 A + 4 x 5 A (USA) 3 x 16 A + 4 x 2 A (Canada) *Contact us for additional combinations
Wire Size	0.2 - 1.5mm ²	20 - 14 AWG
Protection	IP69	Type 4X/6P

female

male







straight, for cables Ø 6-10 mm

Color of coding	Poles
 turquoise blue	6

female male

Part no.	Part no.
96.061.4053.6	96.062.4053.6

Color of coding	Poles
 black	7
 light gray	7
 light blue	7
 turquoise blue	7

female male

Part no.	Part no.
96.071.4053.1	96.072.4053.1
96.071.4053.0	96.072.4053.0
96.071.4053.9	96.072.4053.9
96.071.4053.6	96.072.4053.6

female

male







straight, for cables Ø 10-14 mm

Color of coding	Poles
 turquoise blue	6

female male

Part no.	Part no.
96.061.4153.6	96.062.4153.6

Color of coding	Poles
 black	7
 light gray	7
 light blue	7
 turquoise blue	7

female male

Part no.	Part no.
96.071.4153.1	96.072.4153.1
96.071.4153.0	96.072.4153.0
96.071.4153.9	96.072.4153.9
96.071.4153.6	96.072.4153.6

female

male







angled 90°, for cables Ø 6-10 mm

Color of coding	Poles
 turquoise blue	6

female male

Part no.	Part no.
96.063.4053.6	96.064.4053.6

Color of coding	Poles
 black	7
 light gray	7
 light blue	7
 turquoise blue	7

female male

Part no.	Part no.
96.073.4053.1	96.074.4053.1
96.073.4053.0	96.074.4053.0
96.073.4053.9	96.074.4053.9
96.073.4053.6	96.074.4053.6

female

male







angled 90°, for cables Ø 10-14 mm

Color of coding	Poles
 turquoise blue	6

female male

Part no.	Part no.
96.063.4153.6	96.064.4153.6

Color of coding	Poles
 black	7
 light gray	7
 light blue	7
 turquoise blue	7

female male

Part no.	Part no.
96.073.4153.1	96.074.4153.1
96.073.4153.0	96.074.4153.0
96.073.4153.9	96.074.4153.9
96.073.4153.6	96.074.4153.6

RST20I, DEVICE CONNECTOR, M20, 6/7 POLES

SCREW CONNECTION

TECHNICAL DATA		
	6/7 Poles (screw)	
	IEC	
Thread Size	M20 / M25	
Voltage	250/400 V	600 V
Current	3 x 20 A + 4 x 5 A	3 x 20 A + 4 x 5 A (USA) 3 x 16 A + 4 x 2 A (Canada) *Contact us for additional combinations
Wire Size	0.2 - 1.5mm ²	20 - 14 AWG
Protection	IP69	Type 4X/6P

female

male



modular, straight





Color of coding	Poles
 turquoise blue	6

female

male

Part no.	Part no.
96.061.6053.6	96.062.6053.6

modular, straight

Color of coding	Poles
 black	7
 light gray	7
 light blue	7
 turquoise blue	7

female

male

Part no.	Part no.
96.071.6053.1	96.072.6053.1
96.071.6053.0	96.072.6053.0
96.071.6053.9	96.072.6053.9
96.071.6053.6	96.072.6053.6

female

male



modular, angled 90°





Color of coding	Poles
 turquoise blue	6

female

male

Part no.	Part no.
96.063.6053.6	96.064.6053.6

modular, angled 90°

Color of coding	Poles
 black	7
 light gray	7
 light blue	7
 turquoise blue	7

female

male

Part no.	Part no.
96.073.6053.1	96.074.6053.1
96.073.6053.0	96.074.6053.0
96.073.6053.9	96.074.6053.9
96.073.6053.6	96.074.6053.6

RST20I7, DEVICE CONNECTOR, M25, 7 POLES

SCREW CONNECTION

female

male



modular, straight





Color of coding	Poles
 turquoise blue	6

female

male

Part no.	Part no.
96.061.6253.6	96.062.6253.6

modular, straight

Color of coding	Poles
 black	7
 light gray	7
 light blue	7
 turquoise blue	7

female

male

Part no.	Part no.
96.071.6253.1	96.072.6253.1
96.071.6253.0	96.072.6253.0
96.071.6253.9	96.072.6253.9
96.071.6253.6	96.072.6253.6

female

male



modular, angled 90°





Color of coding	Poles
 turquoise blue	6

female

male

Part no.	Part no.
96.063.6253.6	96.064.6253.6

modular, angled 90°

Color of coding	Poles
 black	7
 light gray	7
 light blue	7
 turquoise blue	7

female

male

Part no.	Part no.
96.073.6253.1	96.074.6253.1
96.073.6253.0	96.074.6253.0
96.073.6253.9	96.074.6253.9
96.073.6253.6	96.074.6253.6

RST20I, CONNECTOR, 6/7 POLES

SCREW CONNECTION

TECHNICAL DATA		
	6/7 Poles (screw)	
	IEC	
Cable Ø	6 - 10 mm / 10 - 14 mm	
Voltage	250/400 V	600 V
Current	3 x 20 A + 4 x 5 A	3 x 20 A + 4 x 5 A (USA) 3 x 16 A + 4 x 2 A (Canada)
Wire Size	0.2 - 1.5mm ²	20 - 14 AWG
Protection	IP69	Type 4X/6P

female





male



splitter connector, for cables Ø 6-10 mm

female

Color of coding	Poles	Part no.
 turquoise blue	6	96.061.4253.6

Color of coding	Poles	female Part no.	male Part no.
 black	7	96.071.4253.1	96.072.4253.1
 light gray	7	96.071.4253.0	
 light blue	7	96.071.4253.9	
 turquoise blue	7	96.071.4253.6	96.072.4253.6





female



splitter connector, for cables Ø 10-14 mm

female

Color of coding	Poles	Part no.
 turquoise blue	6	96.061.4353.6

Color of coding	Poles	female Part no.
 black	7	96.071.4353.1
 light gray	7	96.071.4353.0
 light blue	7	96.071.4353.9
 turquoise blue	7	96.071.4353.6

RST25I3, CONNECTOR, 3 POLES

SCREW CONNECTION

TECHNICAL DATA		
	3 Poles (Screw)	
	IEC	
Cable Ø	6 - 10 mm / 10 - 14 mm / 13 mm - 18 mm	
Voltage	250/400 V	600 V
Current	25 A	20 A
Wire Size	0.75 - 6 mm ²	12 AWG Solid
Protection	IP69	Type 4X / 6P

female

male



straight, for cables Ø 6-10 mm

Color of coding	Poles
■ concrete gray	3

female

male

Part no.	Part no.
96.031.4054.3	96.032.4054.3

straight, for cables Ø 10-14 mm

Color of coding	Poles
■ concrete gray	3

female

male

Part no.	Part no.
96.031.4154.3	96.032.4154.3

female

male



straight, for cables Ø 13-18 mm

Color of coding	Poles
■ concrete gray	3

female

male

Part no.	Part no.
96.031.4554.3	96.032.4554.3

female

male



angled 90°, for cables Ø 6-10 mm

Color of coding	Poles
■ concrete gray	3

female

male

Part no.	Part no.
96.033.4054.3	96.034.4054.3

angled 90°, for cables Ø 10-14 mm

Color of coding	Poles
■ concrete gray	3

female

male

Part no.	Part no.
96.033.4154.3	96.034.4154.3

RST25I3, CONNECTOR, 3 POLES

SCREW CONNECTION

female



splitter connector, for cables Ø 6-10 mm

Color of coding	Poles
■ concrete gray	3

female

Part no.
96.031.4254.3

RST25I3, DEVICE CONNECTOR, M20, 3 POLES

SCREW CONNECTION

TECHNICAL DATA		
	3 Poles (Screw)	
	IEC	UL _{cs}
Thread Size	M20 / M25	
Voltage	250/400 V	600 V
Current	25 A	20 A
Wire Size	0.75 - 6 mm ²	12 AWG Solid
Protection	IP69	Type 4X / 6P

female

male



modular, straight

Color of coding	Poles
■ concrete gray	3

■ concrete gray

3

female

male

Part no.

Part no.

96.031.6054.3

96.032.6054.3

female

male



modular, angled 90°

Color of coding	Poles
■ concrete gray	3

■ concrete gray

3

female

male

Part no.

Part no.

96.033.6054.3

96.034.6054.3

RST25i3, DEVICE CONNECTOR, M25, 3 POLES

SCREW CONNECTION

female

male



standard, straight

Color of coding	Poles
■ concrete gray	3

■ concrete gray

3

female

male

Part no.

Part no.

96.031.5054.3

96.032.5054.3

female

male



modular, angled 90°

Color of coding	Poles
■ concrete gray	3

■ concrete gray

3

female

male

Part no.

Part no.

96.033.6254.3

96.034.6254.3

RST25I5, CONNECTOR, 5 POLES

SCREW CONNECTION

TECHNICAL DATA		
	5 Poles (Screw)	
	IEC	
Cable Ø	6 - 10 mm / 10 - 14 mm / 13 mm - 18 mm	
Voltage	250/400 V	600 V
Current	25 A	20 A (25 A* for 99.575 and 99.576)
Wire Size	0.75 - 6 mm ²	12 AWG (10 AWG for 99.57)
Protection	IP69	Type 4X / 6P

female

male



straight, for cables Ø 6-10 mm

Color of coding	Poles
■ concrete gray	5

female

male

Part no.

Part no.

96.051.4054.3

96.052.4054.3

straight, for cables Ø 10-14 mm

Color of coding	Poles
■ concrete gray	5

female

male

Part no.

Part no.

96.051.4154.3

96.052.4154.3

female

male



straight, for cables Ø 13-18 mm

Color of coding	Poles
■ concrete gray	5

female

male

Part no.

Part no.

96.051.4554.3

96.052.4554.3

straight, for cables Ø 13-18 mm

Color of coding	Poles
■ concrete gray	5

female

male

Part no.

Part no.

99.575.0000.7

99.576.0000.7

RST25I5, CONNECTOR, 5 POLES

SCREW CONNECTION

female



splitter connector, for cables Ø 6-10 mm

Color of coding	Poles
■ concrete gray	5

female

Part no.

99.584.0000.7

splitter connector, for cables Ø 10-14 mm

Color of coding	Poles
■ concrete gray	5

female

Part no.

99.585.0000.7

RST25I5, DEVICE CONNECTOR, M20, 5 POLES

SCREW CONNECTION

TECHNICAL DATA		
	5 Poles (Screw)	
	IEC	
Thread Size	M20 / M25	
Voltage	250/400 V	600 V
Current	25 A	20 A
Wire Size	0.75 - 6 mm ²	12 AWG Solid
Protection	IP69	Type 4X / 6P

female

male



modular, straight

Color of coding	Poles
 concrete gray	5

female

male

Part no.

Part no.

96.051.6054.3

96.052.6054.3

female

male



modular, angled 90°

Color of coding	Poles
 concrete gray	5

female

male

Part no.

Part no.

96.053.6054.3

96.054.6054.3

RST25I5, DEVICE CONNECTOR, M25, 5 POLES

SCREW CONNECTION

female

male



standard, straight

Color of coding	Poles
 concrete gray	5

female

male

Part no.

Part no.

96.051.5054.3

96.052.5054.3

female

male



modular, angled 90°

Color of coding	Poles
 concrete gray	5

female

male

Part no.

Part no.

96.053.6254.3

96.054.6254.3

SPECIALTY HARNESSES

Plan with confidence & deliver on-time. Wieland engineers work with you to develop a custom and specialized solution for your application.



RST16I, CABLE ASSEMBLY, 2-5 POLES



TECHNICAL DATA

Rated current:	16 A	Combinations:	Male to female, male to free end, and female to free end
Degree of protection (IP):	Type 4X / 6P	Approvals:	
Lockable:	Self-locking (unlocking by hand)	Contact us for part numbers and additional options.	
Type of construction:	Cable screw gland		
Color of coding:	All codings possible		
Poles:	2 to 5		

Cable type can be selected according to application, by making use of most widely used North American cable types, such as SJOW, STOW, SOOW, or TC-ER.

RST20I, CABLE ASSEMBLY, 2-7 POLES



TECHNICAL DATA

Rated current:	16 A or 20 A	Combinations:	Male to female, male to free end, and female to free end
Degree of protection (IP):	Type 4X / 6P	Approvals:	
Lockable:	self-locking (unlocking by tool)	Contact us for part numbers and additional options.	
Type of construction:	Cable screw gland		
Color of coding:	All codings possible		
Poles:	2 to 7		

Cable type can be selected according to application, by making use of most widely used North American cable types, such as SJOW, STOW, SOOW, or TC-ER.

RST20/25, ACCESSORIES



cover piece, tethered

Color	Poles	for Male	for Female
■ black	2/3	99.416.6205.2	99.414.6205.2
□ light gray	2/3	99.415.6205.2	99.413.6205.2



cover piece, tethered

Color	Poles	for Male	for Female
■ black	4/5	99.532.0000.7	99.530.0000.7
□ light gray	4/5	99.531.0000.7	99.529.0000.7



cover piece, tethered

Color	Poles	for Male	for Female
■ black	6/7	99.591.0000.7	99.589.0000.7



cover piece, untethered

Color	Poles	for Male	for Female
■ black	2/3	05.564.4453.1	Z5.564.4553.1
□ light gray	2/3	05.564.4453.0	Z5.564.4553.0



cover piece, untethered

Color	Poles	for Male	for Female
■ black	4/5	05.565.9953.1	Z5.565.9853.1
□ light gray	4/5	05.565.9953.0	Z5.565.9853.0



cover piece, untethered

Color	Poles	for Male	for Female
■ black	6/7	Z5.569.5353.1	Z5.569.5253.1

RST20/25, ACCESSORIES



manual disconnect tool, for connectors 2 to 5 poles

Color	Part no.
■ black	05.564.8653.1
■ leaves green	05.564.8653.7
■ concrete gray	05.564.8653.3

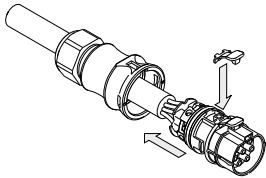

manual disconnect tool, for connectors 6 and 7 poles

Color	Part no.
■ black	06.562.8753.0

The manual disconnect tool allows easy separation of a mated female cable mounted connector without the need for a screwdriver.

locking slide - safety Clip



Color	Part no.
■ black	05.583.2900.1
■ concrete gray	05.583.2900.3



sealing ring

Color	Ø Size	Part no.
■ black	6 - 10 mm	05.565.0400.0
■ black	8 - 12 mm	06.564.0383.0
■ black	10 - 14 mm	05.565.0500.0
■ black	13 - 18 mm	05.565.2600.0



mounting plate, for splitter connectors

Color	Part no.
■ black	01.006.1553.1
□ light gray	01.006.1553.0



sample case, RST20i2...i7

Part no.
99.431.0000.0

RST® POWER

The high-current connector for demanding loads.



FEATURES

- + 4 and 5 poles
- + 53 A rated current
- + Mechanical coding
- + Screw and spring contacts for easy field installation
- + Crimp contacts also available

APPLICATIONS

- + Outdoor and other areas that require a high degree of protection against the ingress of water & dust
- + Higher electrical loads
- + Ideal for applications requiring a lot of power such as server farms and data centers
- + Anywhere fast changes and modular designs are needed

RST5I, CONNECTOR, 4/5 POLES

SCREW CONNECTION

TECHNICAL DATA		
	4/5 Poles (screw)	
	IEC	
Cable Ø	15 - 25 mm / 20 - 32 mm	
Voltage	250/400 V	600 V
Current	50 A	53 A
Wire Size	4 - 16 mm ²	12 - 6 AWG
Protection	IP 66/67/69	Type 6P

female

male



straight, for cables Ø 15-25 mm

Color of coding	Poles
■ black	4

female

male

Part no.	Part no.
97.041.4053.1	97.042.4053.1

Color of coding	Poles
■ black	5

female

male

Part no.	Part no.
97.051.4053.1	97.052.4053.1

female

male



straight, for cables Ø 20-32 mm

Color of coding	Poles
■ black	4

female

male

Part no.	Part no.
97.041.4253.1	97.042.4253.1

Color of coding	Poles
■ black	5

female

male

Part no.	Part no.
97.051.4253.1	97.052.4253.1

RST50i, DEVICE CONNECTOR, M32, 4/5 POLES

SCREW CONNECTION

female

male



standard, straight, fixed in position

Color of coding	Poles
■ black	4

female

male

Part no.	Part no.
97.041.5553.1	97.042.5553.1

Color of coding	Poles
■ black	5

female

male

Part no.	Part no.
97.051.5553.1	97.052.5553.1

female

male



standard, straight, not fixed in position

Color of coding	Poles
■ black	4

female

male

Part no.	Part no.
97.041.5053.1	97.042.5053.1

Color of coding	Poles
■ black	5

female

male

Part no.	Part no.
97.051.5053.1	97.052.5053.1

Crimp variants are also available.

RST50, ACCESSORIES



cover cap

Color

■ black

Part no.

Z5.567.5653.0



adapter ring, M40

Color

■ black

Part no.

05.568.1853.0



sample case, RST50i5

Part no.

99.628.0000.0

CABLE GLANDS + VENTED PLUGS

AFFORDABLE SEALING TECHNOLOGY FOR OUTDOOR APPLICATIONS

Cable glands and fittings provide strain relief for cables and high protection against dirt, dust, water and other liquids for electric and electronic systems, up to IP 68/ 4X. **Ventilation glands & plugs**, also known as Pressure Balance Elements (PBEs), balance the pressure difference between inside and outside of an enclosure. At the same time, these devices provide a high degree of protection of up to IP 67/ 4X. This prevents corrosion and water condensation inside the enclosure and **extends the lifetime of the entire system**.



CABLE GLANDS

Affordable strain relief and protection against water, dirt and dust.

IP 68/4X



VENTED GLANDS

Cable gland and PBE (pressure balancing element) in one product!

IP 67/4X



VENTED PLUGS (PBE)

Allows air to move, balancing pressure, while keeping water out.

IP 67/4X

EASY SNAP-IN!

Snap-in makes installation a breeze

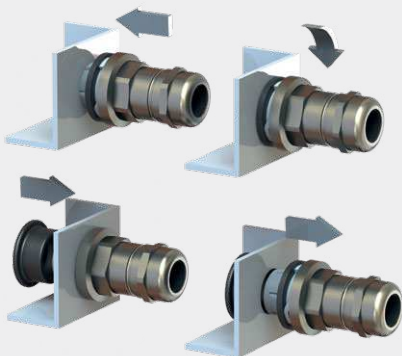

BENEFITS

- ▶ High IP rating with gas permeability
- ▶ Strain Relief + enclosure protection
- ▶ Extended system lifetime
- ▶ Perfect fit with a range of sizes

FEATURES AT A GLANCE

- ▶ IP 67/68/4X
- ▶ Temperature range of -20 °C to +100 °C and UV protection
- ▶ Snap-in technology for device mounting
- ▶ Available in plastic (polyamide) and brass (nickel plated)
- ▶ Sizes in metric, PG, and NPT



wieland

GLOBAL HEADQUARTERS

Wieland Electric GmbH
Brennerstraße 10 – 14
96052 Bamberg · Germany

Tel +49 951 9324-0
Fax +49 951 9324-198
info@wieland-electric.com

NORTH AMERICA

Wieland Electric Inc.

Toll Free 1 800 WIELAND (943-5263)
sales@wielandinc.com

United States

Tel +1 314 735 0038
Fax +1 314 405 9363

Canada

Tel +1 905 829 8414
Fax +1 905 829 8413

34.205.0166.1 07/25

Worldwide in over 70 Countries:

www.wieland-electric.com